

Rotary Sensor

Z Series 7mm size

»SUMMARY

7mm SMD Rotary Sensor with newly developed base material. Compact 7mm size provides extra spacing savings. Changing from paper phenol film and other materials to an enhanced carbon resin provides increased performance. Improved linearity and reflow resistance are achieved compared to conventional design. Higher performance sensor properties.

RoHS compliant and suitable for reflow soldering.

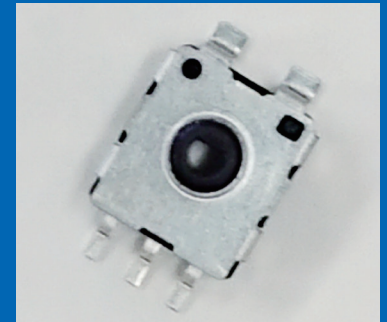

»FEATURES

Withstands double reflow

- ▶ Resistance change minimized to maximum 1% after double reflow.

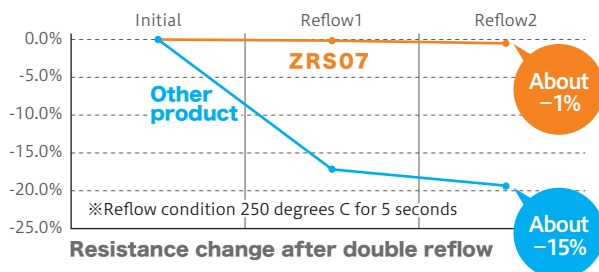

»PRODUCT APPLICATIONS

- Numerous robotic and servo functions in radio controlled products
- Position controller for radio controller

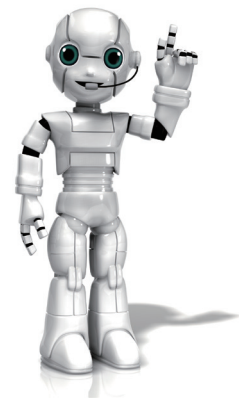

»BASIC SPECIFICATIONS

External dimension

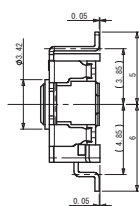
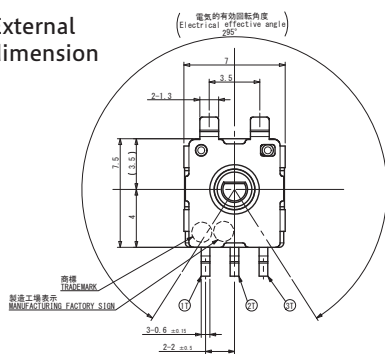

各端子のばらつきは、0.15mm以内です。
Fluct. = 0.15mm max

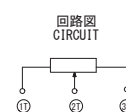
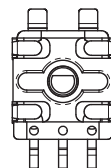

- Nominal total resistance: 5K ohm
- Rated voltage: 5V DC
- Mechanical rotation angle: Endless
- Electrical rotation angle: 295 degrees
- Guaranteed range of linearity: 280 degrees
- Linearity: +/-1.5%
- Operating temperature: -40 degrees C to +85 degrees C
- Rotational Life: 500,000 cycles